



CDC11 Specification

V3.1-2021.1.19

Cloud drive intelligent technology Co.,Ltd

Preface

Dear users:

To ensure better performance of your ebike, please read through the CDC6 instruction carefully before using it. We will inform you of all the details, including the installation and function setting of the display with the most concise words. Meanwhile, the specification will also help you to solve possible malfunction.



Contents

1. Product introduction.....	3
2. Technical parameters.....	4
3. Material and external dimensions.....	4
4. Installation instructions.....	5
5.Button definition.....	6
6. Introduction to the main interface.....	7
7. Introduction to the setting interface.....	9
A.Unit setting.....	10
B.Passwords function open/close setting.....	10
C.Passwords setting.....	11
8. Q&A.....	11
Enclosed: Error code definition table.....	12

1.Product instruction

CDC11 products uses the 2.4-inch LCD color screen with a light and beautiful button. Frosted texture of black, beautiful appearance. The display interface bar frame is very clear, with backlight light sense design. Double side printed board , nylon buckle and ABS material shell, under the temperature ranging from -20°C to 60°C,which can ensure the good mechanical performance of the products.

The one display can match 24V/36V/48V battery. At the same time it integrates 24V, 36V and 48V front lights switch function. With another CDBL_C product of our company will greatly simplify the handlebar cable.

The display main interface has the white and black theme background.The display can switch between the two theme backgrounds automatically to show clearly even though it's under different conditions of external light intensity.



White theme background



black theme background

CDC11 function Summary:

- ◆ Total distance and single distance indication
- ◆ Maximum speed and average speed indication
- ◆ Current speed indication

- ◆ Car lamp display
- ◆ PAS level selection
- ◆ Output power indication
- ◆ Battery residual capacity indication
- ◆ Error code definition
- ◆ Unit switching: km/mile
- ◆ USB charging function
- ◆ Blue tooth function (customized)
- ◆ 6Km/h walk function
- ◆ Pass words function:it can be customized

2.Technical parameters

Voltage: 24V/36V/48V

Current: 24V/35mA, 36V/27mA, 48V/24mA

Ambient temperature in use: -20°C to 60°C

Ambient humidity in use: 0-100%RH

Protection grade: IP65

Screen viewing angle: Horizontal view-angle 160°

Vertical viewing Angle 160°

screen brightness: 400~450 lumen (show clear in the sun)

3.Dimension and size

Real product and dimension:

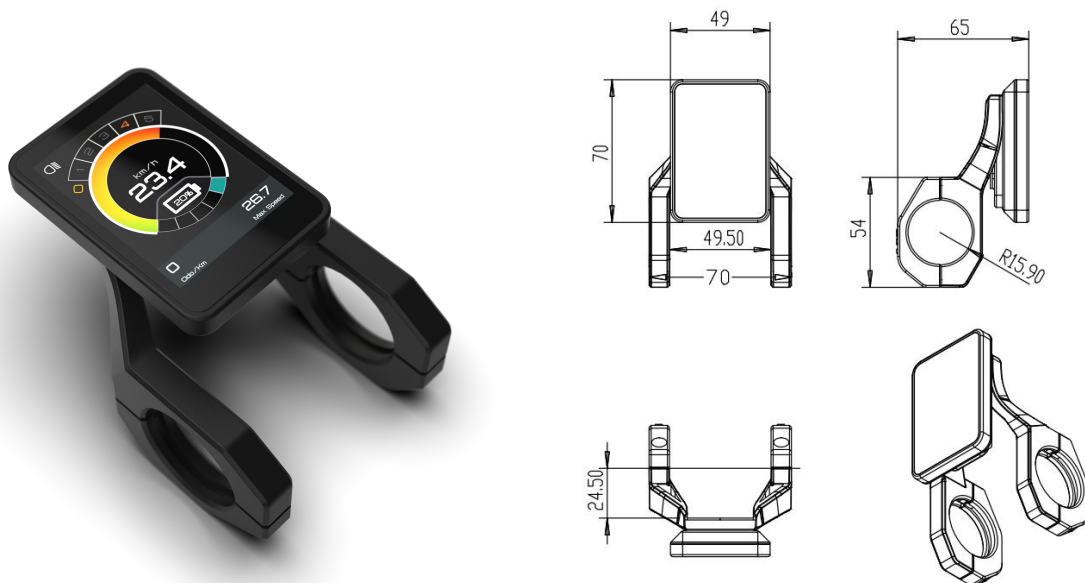

Real product and dimension of the button:

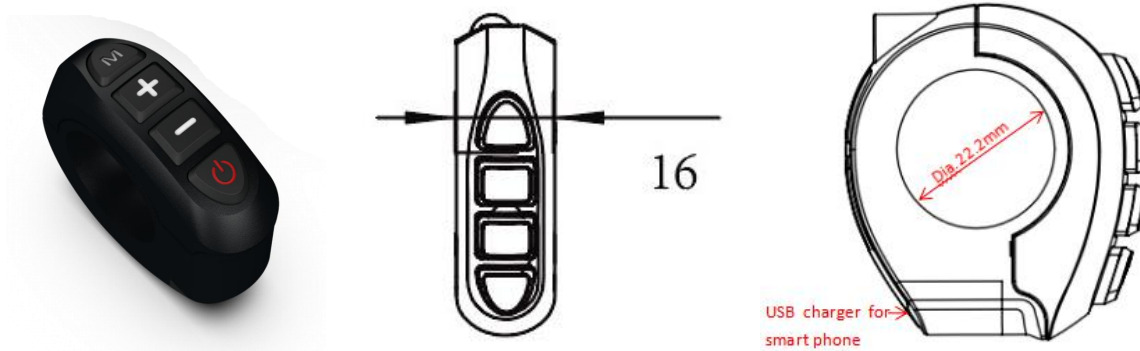

4.Installation instruction

Erection explosion diagram:





The display and button will be fixed on the handlebar, and then adjust the angle of view, and the button will be installed in the easily controlled position. Tighten the screws to finish the installation. (The below picture is installation rendering)





5.Button definition

button	operation	function
	hold 3S	1.It will enter into the setting menu after holding 3s in the main interface; 2.It will turn to main interface after holding 3s in the setting interface.
	click	1.In the main interface, click it will turn on/off the USB charging function;

		2.In the setting function, it has confirm function. 3.it can switch the passwords digit when in the passwords interface of the menu;
	hold 3S	Nothing
	click	1.Increase the lever when in the main interface; 2.Switch the options when in the setting interface; 3.Increase the numeric value of the password when in the passwords interface;
	hold 3S	1.In the main interface, can turn on 6Km/h walk function(and when you release it, the 6km/h walk function will be off);
	click	1.It can decrease the lever when in the main interface; 2.It can switch the options when in the setting interface; 3.Decrease the numeric value of the pass word in the passwords interface;
	hold 3S	1.Power off in any interface;
	click	1.Power on when it is in the off state; 2.Turn on/off the lamp when in the main interface; 3.Switch the password digit when in the interface of passwords input interface.

6.Instruction of the main interface

If the passwords function was customized, it will show passwords input interface after turning on. In the passwords input interface, click  or  button to set the right numeric value. Click  button to switch to the right password digit. It will enter the main interface if you input the correct passwords; otherwise, you should input again.The default passwords is 0000.

Note: Please keep in mind the pass words after you modified it in order to that the display can' t be opened.





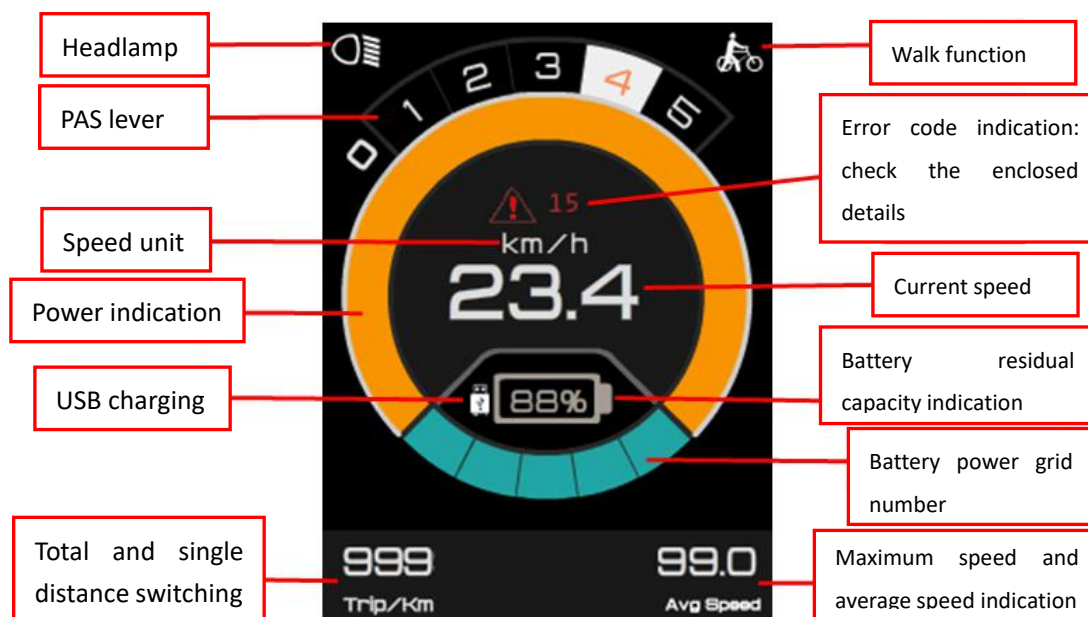

The main interface is shown in the below picture(it is the same function show in the white and black theme).

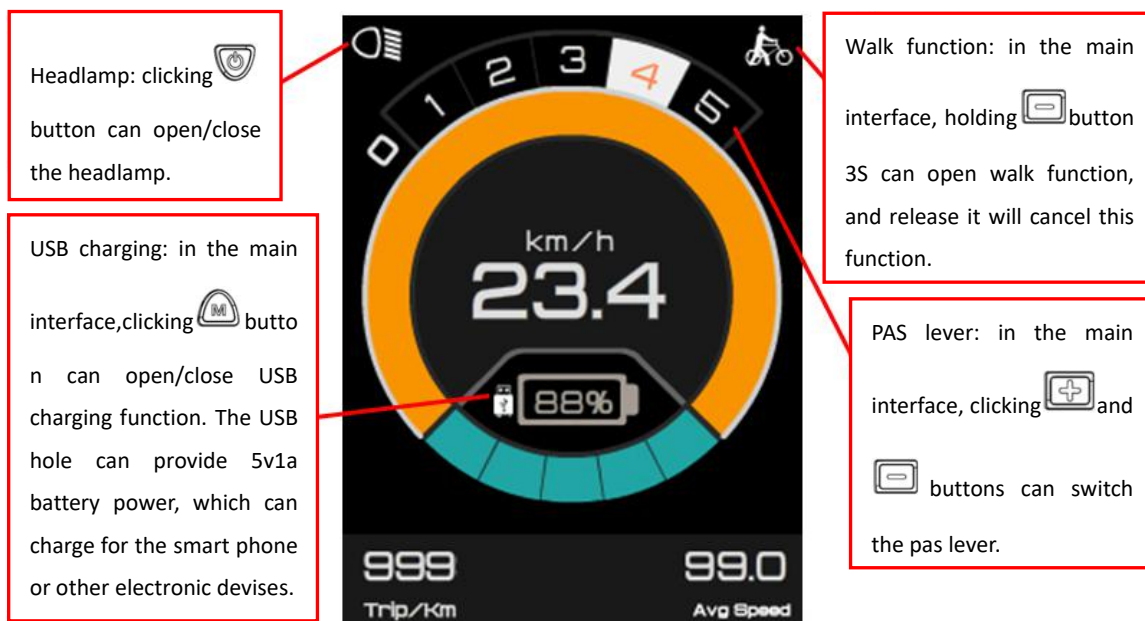

In the main interface, operations of each function(switch the lever/power on the walk function/turn on or off the lamp/USB charging function and so on) is shown in the below picture.



7.Setting interface instruction

In the main interface, holding  button 3S will enter the setting interface; Then holding  button 3S, it will back to main interface; Clicking  or  button can switch the options; Clicking  button can enter the setting options. The setting interface is shown in below picture.

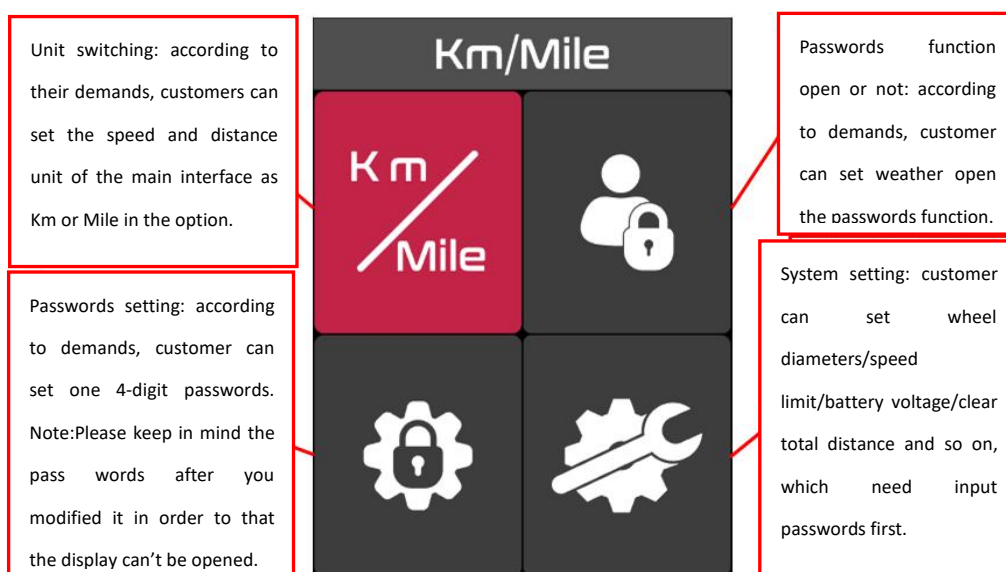

A. Unit setting

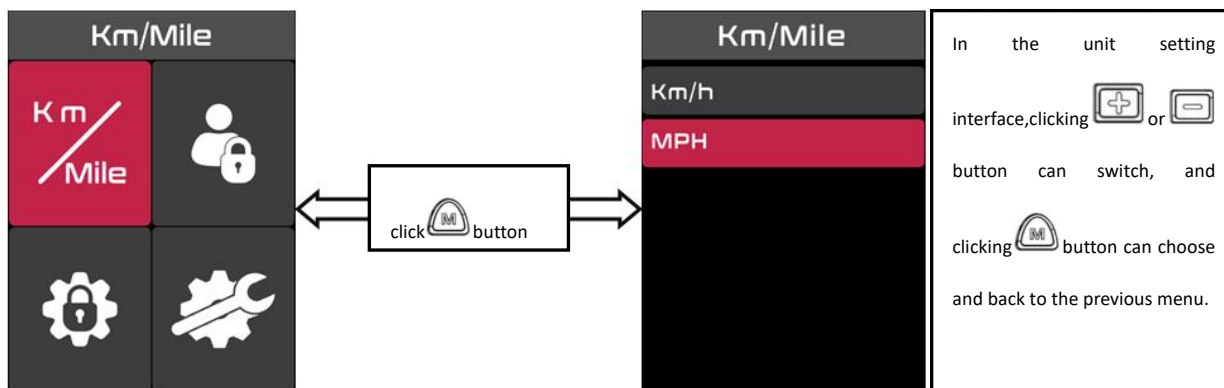

B. Passwords function open/close setting

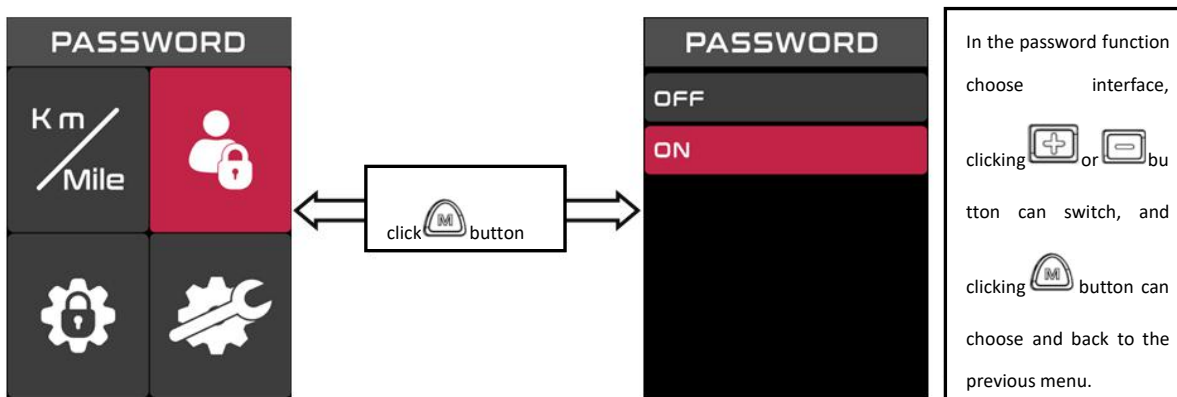

Cloud drive intelligent technology Co.,Ltd

C.Passwords setting

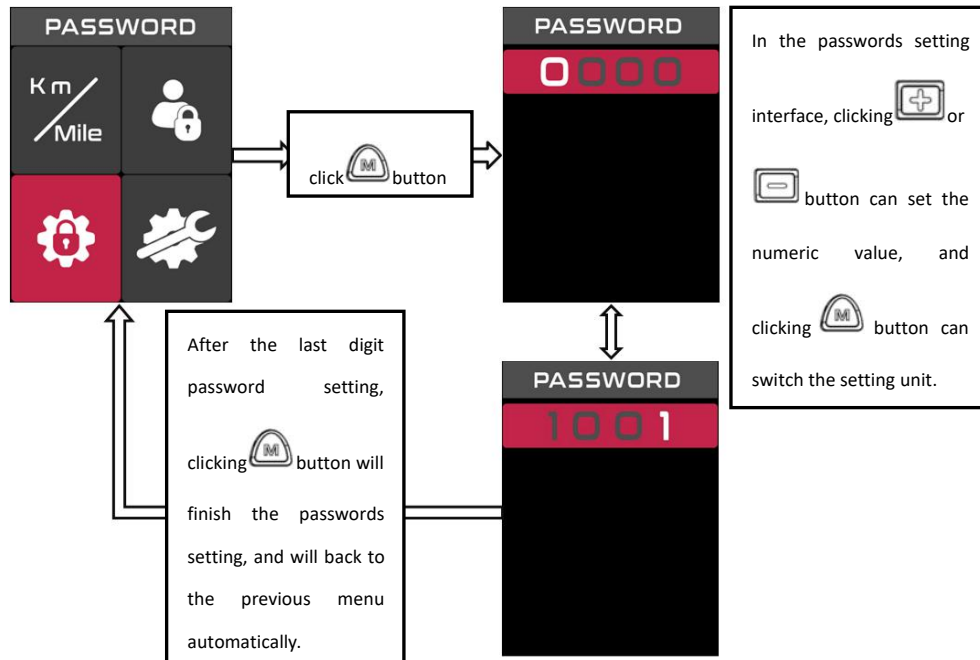

Note: Please keep in mind the pass words after you modified it in order to that the display can't be opened.

8.Q&A

Q: Why the display is not able to start up?

A: Check the connector that between display and controller.

Q: How to deal with the error code?

A: Fix it to the maintenance place immediately. If it cannot be resolved, you

Enclosed: Error code definition table

S/N.	Error code	definition	others
1	0x04	The throttle is not in place (stop on a hing position)	
2	0x05	Throttle is failure	
3	0x06	Under voltage protection	The display is off display
4	0x07	Over voltage protection	
5	0x08	The hall signal cable of the motor is failure	
6	0x09	The motor phase cable is failure	
7	0x11	The motor temperature sensor is failure	
8	0x12	The current sensor is failure	
9	0x13	The temperature sensor in the battery is failure	
10	0x14	The temperature in the controller reaches the temperature protection point	
11	0x15	The temperature sensor in the controller is failure	
12	0x21	The PAS is failure	
13	0x22	BMS communication is failure	The display will show -- not the error code if it can't read the information.
14	0x23	The lamp is failure	
15	0x24	The lamp sensor is failure	
16	0x25	The torque signal of the torque sensor is failure	
17	0x26	The speed of the torque sensor is failure	
18	0x30	Communication is failure	The display can detect the failure communication automatically and the the controller won't upload the information.